

Tumbler Patterns

The Shapes:

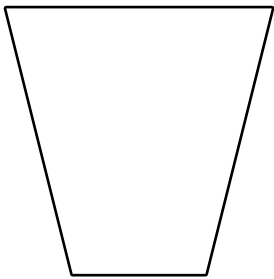

TUM

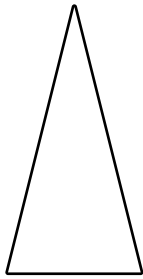

ITRI 2:1

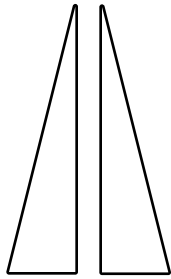

RTRI 4:1

A tumbler is a trapezoid that is 1:1 height to width. The length of the top edge is twice the length of the bottom edge.

Assembly:

Assemble in rows

Patterns:

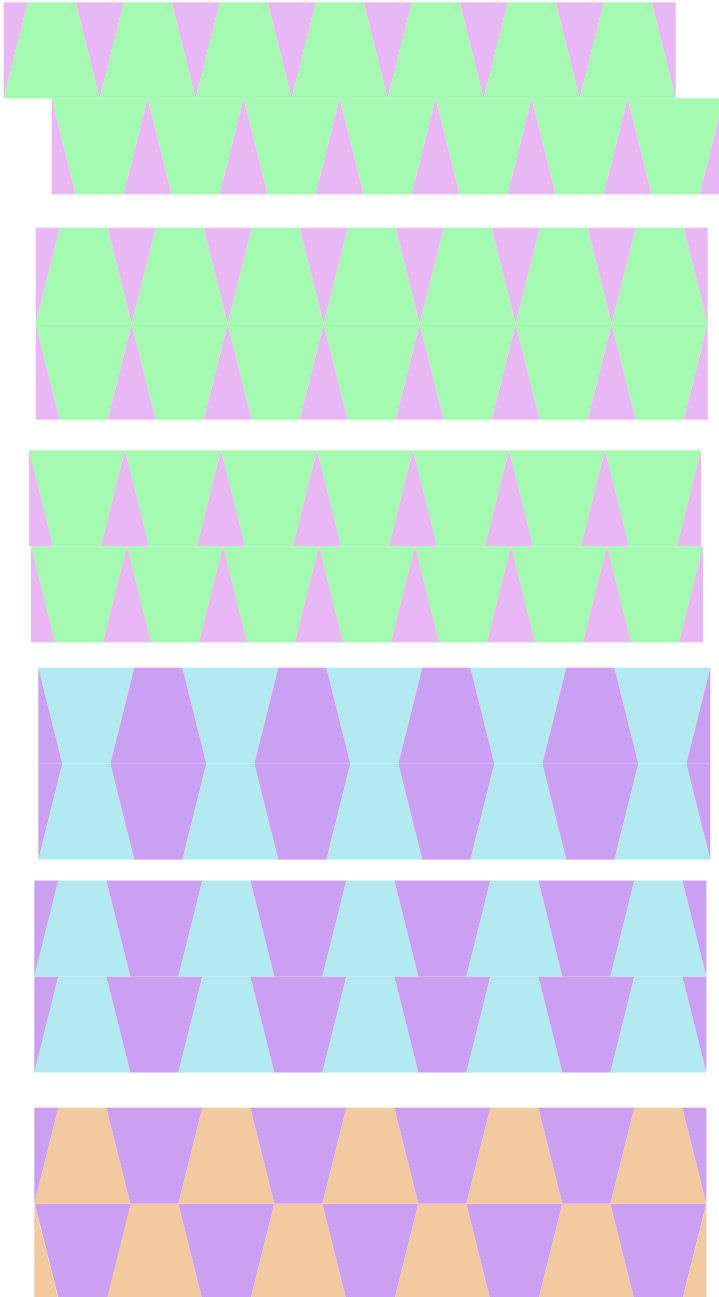

Size:

2, 3, 4, 5 inch

Seam Type:

Standard

Scale SVG file to 10" x 10"

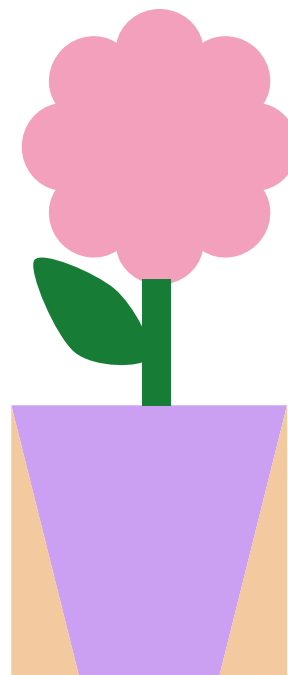

Tumbler Pattern Shapes

Cut Shapes True to Size

Set Printer Scale to 100% to get an accurate representation of the shapes.

Tumbler (TUM)

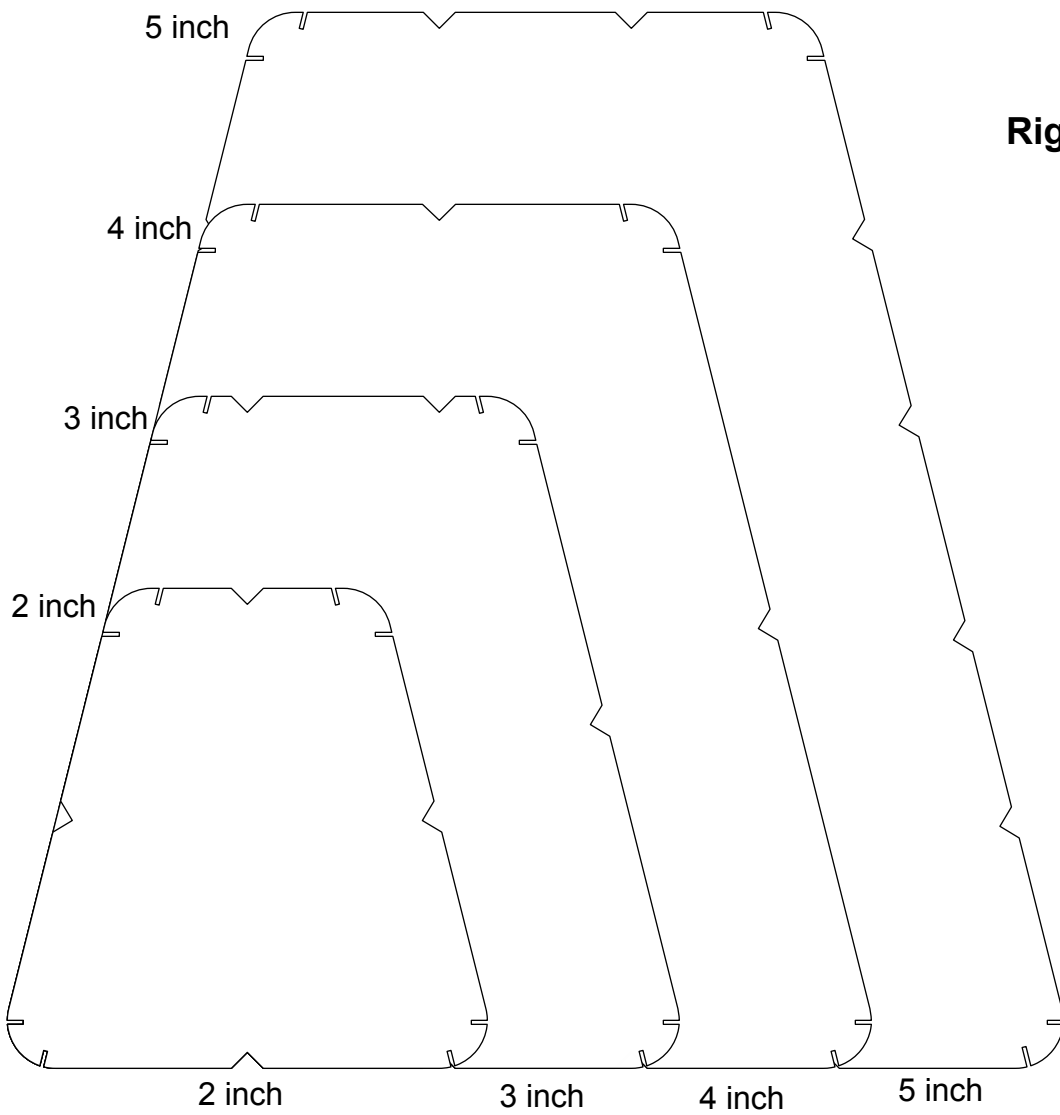

Right Triangle 4:1 (RTRI)

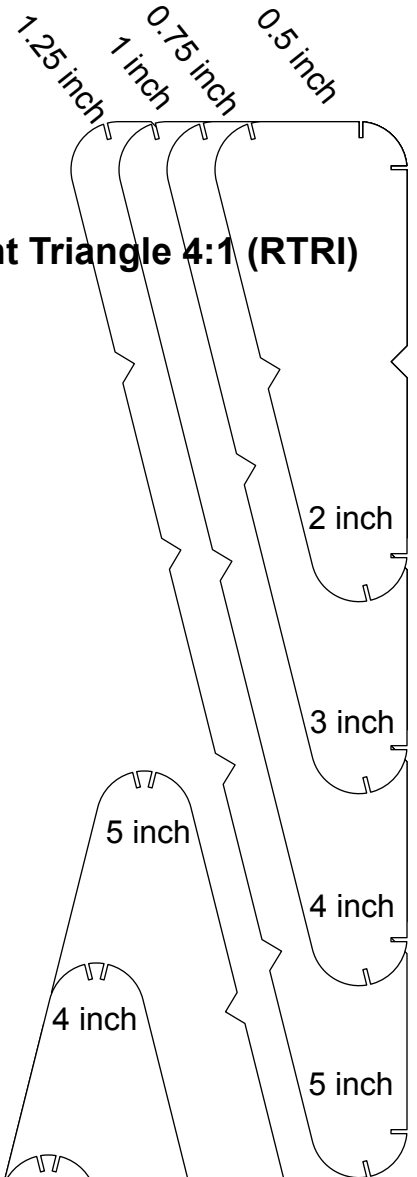

Sizes noted are the finished size after sewing. A 1/4 inch seam allowance has been added to each shape

Isosceles Triangle 2:1 (ITRI)

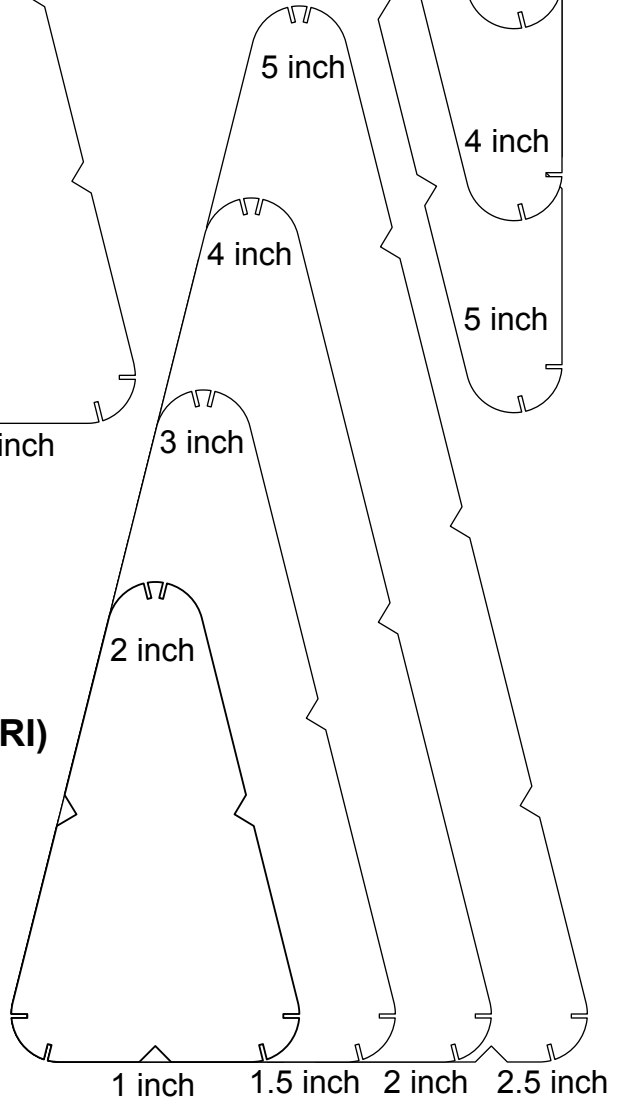

Tumbler Cutting Plans

2 inch

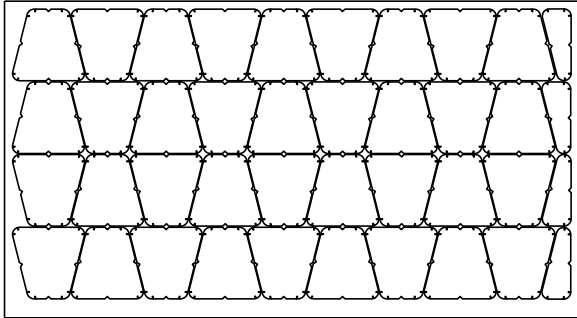

36 TUM 4 RTRI

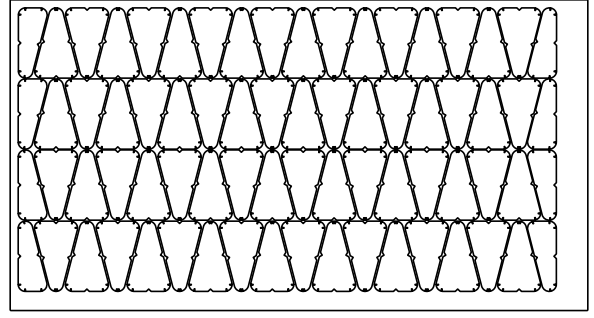

64 ITRI 8 RTRI

3 inch

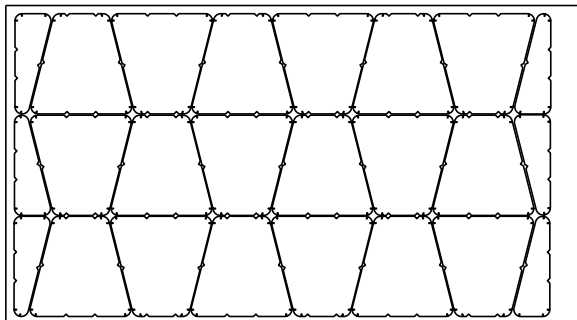

18 TUM 6 RTRI

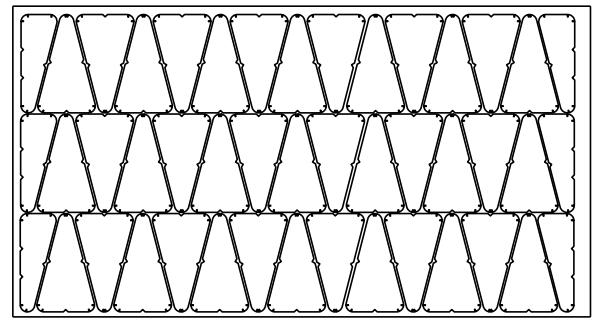

39 ITRI 6 RTRI

4 inch

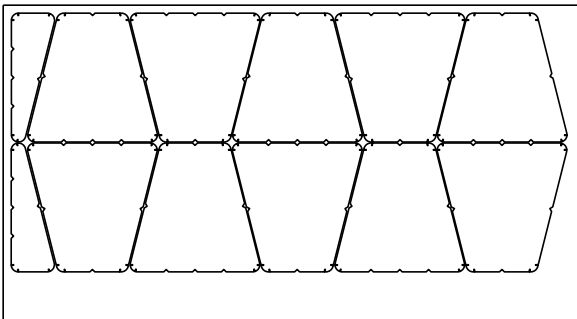

10 TUM 2 RTRI

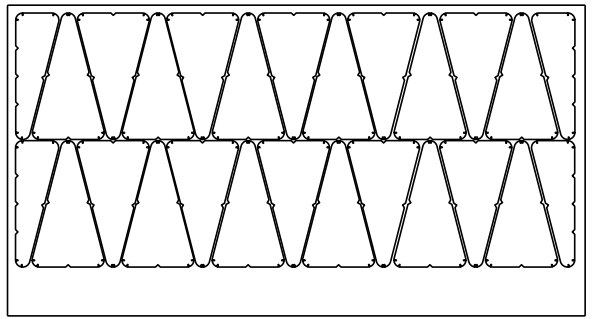

22 ITRI 4 RTRI

5 inch

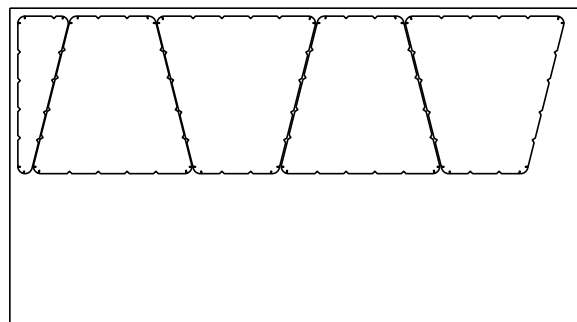

4 TUM 1 RTRI

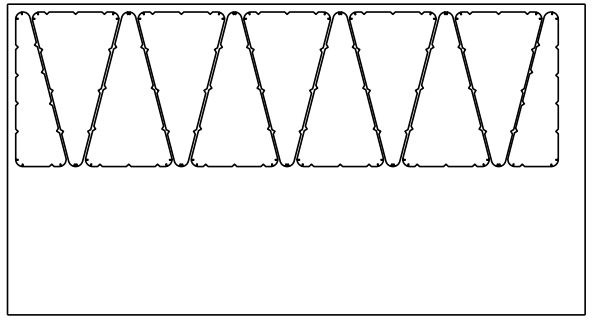

9 ITRI 2 RTRI

Tumbler Set

Assemble in rows.

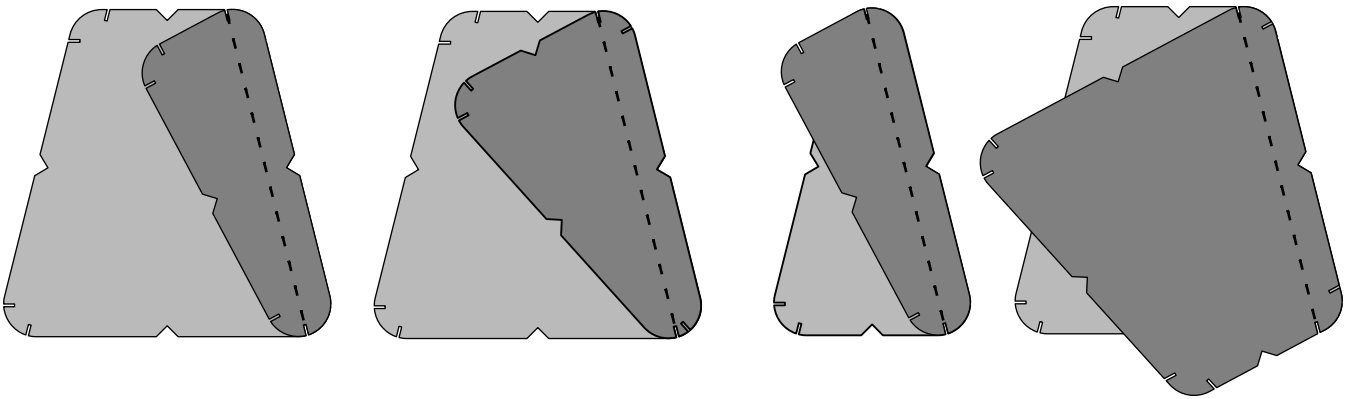
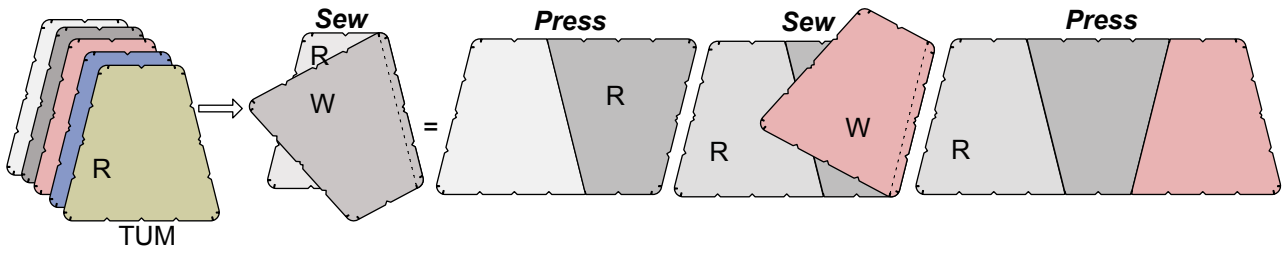

Design 1: Side by Side

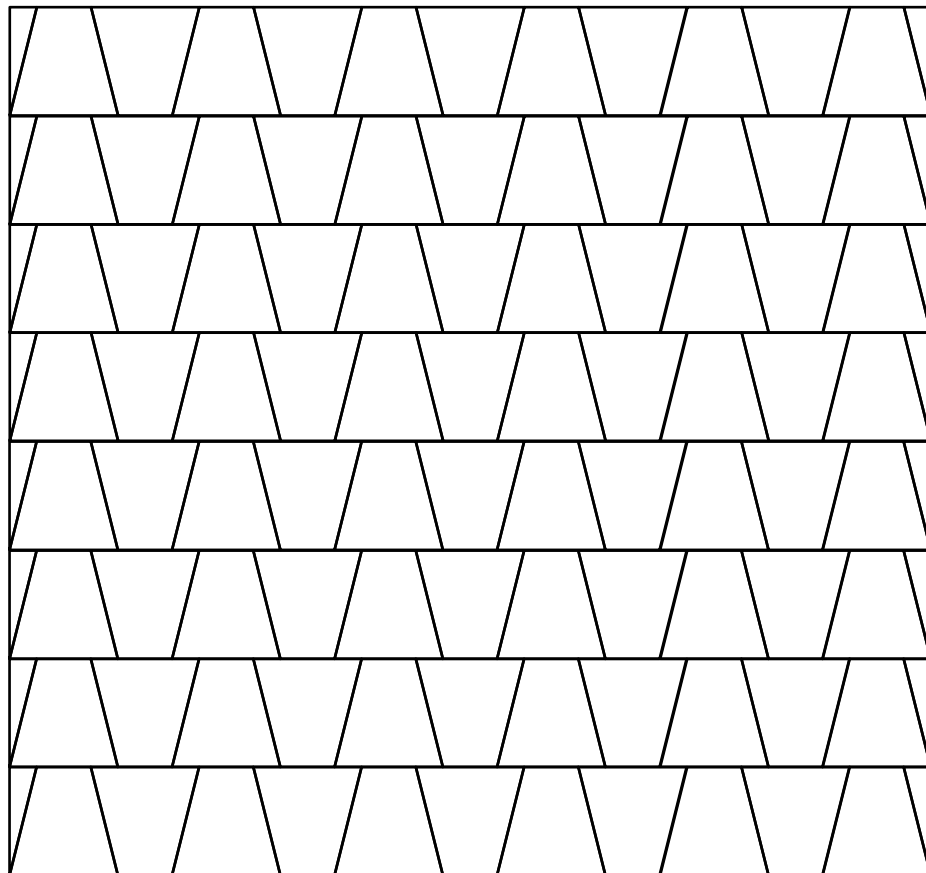
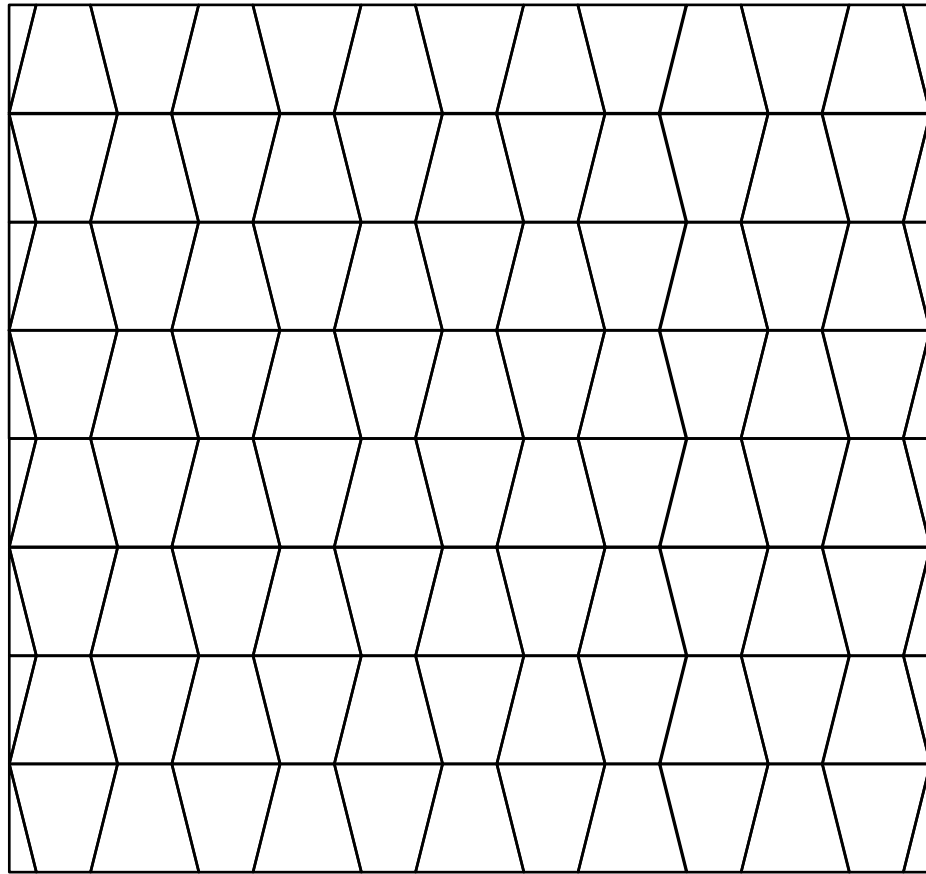

Tumbler Quilt

Design 2: Tumblers alternating with Triangles

